





ORIGINAL

## Development of a Wearable Technology for the Early Detection of Pressure Ulcers in Nursing Homes

### Desarrollo de una tecnología portátil para la detección precoz de úlceras por presión en residencias de ancianos

Bhargavi Deshpande<sup>1</sup>  , Malathi Hanumanthayya<sup>2</sup>  , Ram Niwas<sup>3</sup>  

<sup>1</sup>ISDI - School of Design & Innovation, ATLAS SkillTech University. Mumbai, India.

<sup>2</sup>Department of Life Sciences, School of Sciences, JAIN (Deemed-to-be University). Karnataka, India.

<sup>3</sup>College of Nursing, Teerthanker Mahaveer University. Moradabad, Uttar Pradesh, India.

**Cite as:** Deshpande B, Hanumanthayya M, Niwas R. Development of a Wearable Technology for the Early Detection of Pressure Ulcers in Nursing Homes. *Salud, Ciencia y Tecnología*. 2023; 3(S1):458. <https://doi.org/10.56294/saludcyt2023458>

Submitted: 13-06-2023

Revised: 30-06-2023

Accepted: 04-08-2023

Published: 05-08-2023

Editor: William Castillo-González 

Associate Editor: Fasi Ahamad Shaik 

#### ABSTRACT

As the body deteriorates and develops various ailments, aging inevitably impacts health. When dealing with these issues, healthcare is crucial to healing. Hospital patients' physical and emotional health is worsened by age-related pressure ulcers (PU). This study suggested developing a wearable device for nursing homes to use in the early diagnosis of PU. We also use data augmentation methods to increase our dataset's size and improve our model's robustness. The suggested system uses a wearable gadget to continuously track the patient's location and wireless communication with a tablet to notify the nurse when a patient turn is approaching, following the hospital's policy. The hospital's cloud technology allows for centralized monitoring by recording and updating the turning operation and the patient's position, which is continuously tracked. In a controlled environment, the system could track the patient's posture continually and precisely identify typical patient poses. A Water Wave Optimization with Convolutional Neural Network (WWO-CNN) method is described to prevent PU better. Our method achieves an overall accuracy, precision, recall, and F1-score, which is encouraging. Our practice offers a more effective and precise solution for the detection and classification of PU when compared to existing research that essentially uses WWO-CNN-based algorithms. Our method can potentially enhance early diagnosis and treatment of PU, leading to better patient outcomes and lower medical costs.

**Keywords:** Wearable Device; Pressure Ulcers; Nurses; Hospital's Cloud Technology; Water Wave Optimization with Convolutional Neural Network.

#### RESUMEN

A medida que el cuerpo se deteriora y desarrolla diversas dolencias, el envejecimiento repercute inevitablemente en la salud. A la hora de tratar estos problemas, la atención sanitaria es crucial para la curación. La salud física y emocional de los pacientes hospitalizados empeora con las úlceras por presión (UPP) relacionadas con la edad. Este estudio propone desarrollar un dispositivo wearable para que las residencias de ancianos lo utilicen en el diagnóstico precoz de las UP. También utilizamos métodos de aumento de datos para aumentar el tamaño de nuestro conjunto de datos y mejorar la solidez de nuestro modelo. El sistema sugerido utiliza un gadget wearable para rastrear continuamente la ubicación del paciente y la comunicación inalámbrica con una tableta para notificar a la enfermera cuando se acerca el turno del paciente, siguiendo la política del hospital. La tecnología en la nube del hospital permite una supervisión centralizada al registrar y actualizar la operación

de giro y la posición del paciente, que se rastrea continuamente. En un entorno controlado, el sistema podría realizar un seguimiento continuo de la postura del paciente e identificar con precisión las poses típicas del paciente. Se describe un método de optimización de ondas de agua con red neuronal convolucional (WVO-CNN) para prevenir mejor las UP. Nuestro método logra una exactitud, precisión, recuperación y puntuación F1 generales alentadoras. Nuestra práctica ofrece una solución más eficaz y precisa para la detección y clasificación de las UP en comparación con las investigaciones existentes que utilizan esencialmente algoritmos basados en WVO-CNN. Nuestro método puede mejorar potencialmente el diagnóstico precoz y el tratamiento de las UPP, lo que se traduce en mejores resultados para los pacientes y menores costes médicos.

**Palabras clave:** Dispositivo Wearable; Úlceras por Presión; Enfermeras; Tecnología en la Nube del Hospital; Optimización de Ondas de Agua con Red Neuronal Convolucional.

## INTRODUCTION

PU caused by medical devices are increasingly acknowledged as a public health issue for healthcare institutions. Pressure injuries caused by medical equipment happen when the skin or underlying tissues are repeatedly pressed against or sheared by the devices. Any medical gadget has the potential to result in pressure wounds. Pressure injuries caused by medical equipment typically happen near, under, or in the shape of the devices. Medical device users are twice as likely to have pressure injuries as those who do not. People 75 and older, less mobile, with changed skin microclimates, underweight, and dependent on medical equipment are at a higher risk of developing a pressure injury. Medical gadgets often cause pressure injuries in the head, face, ears, heels, feet, neck, sacrum, and buttocks.<sup>(1)</sup>

Despite all medical improvements, PU is an ongoing global public health issue connected to patient safety. One of the worst things that may happen to hospitals and their therapeutic missions is the spread of PUs. Wounds to the skin and underlying tissue caused by pressure force alone or combined with shear are known as Pus and typically occur over a bony prominence. Major medical, psychological, and social issues arise due to PUs, which reduce patients' quality of life and make them more dependent and feebler. They increase healthcare costs and are recognized as a reflection of the standard of care hospitals provide. In most clinical contexts, PUs can be predicted and prevented using therapies and evidence-based nursing practice.<sup>(2)</sup>

The NPIAP broadened the definition of a medical device to encompass items like eyeglasses and gadgets without precise medical use. The panel offers the following description and justification of device-related pressure ulcers (DRPU) to distinguish them from body-weight-induced PUs: a DRPU involves interacting with a piece of equipment or object that comes into direct touch with the skin or is implanted transdermally under the skin, creating focal and localized forces that distort the skin's surface and deeper tissues. A DRPU brought on by a tool or item, differs from a PU, primarily brought on by the forces of gravity. The appearance of skin damage and more profound tissue damage that closely resembles that of the device in terms of shape and distribution is caused by the localized nature of the device's contact with the patient's tissue. The name DRPU concentrates the attention of medical professionals and people solely on PU connected with medical devices.

A DRPU may be brought on by a medically unrelated object, device, or product. The term DRPU is used throughout this consensus statement to emphasize how crucial it is to comprehend that pressure ulceration may be related to medical and non-medical devices.<sup>(3,4)</sup>

Patients and customers of all ages bear a terrible burden when they develop PU, which can cause problems with comfort, discomfort, quality of life, costs, and a prolonged hospital stay. They might trigger an event that endangers lives. PU present a unique difficulty in healthcare. Included are guidelines, audits, the application of suitable preventative and rehabilitative techniques, resources, evidence-based practice, qualified personnel, and professional participation. Despite years of clinical study into pressure ulcer prevention and treatment, their incidence, prevalence, and mortality remain high. Pressure ulcer therapy costs a median of €1,71 per patient, per day, with prevention costing a median of €2,65 per patient, per day. This issue arises because pressure ulcer prevention and treatment lacks methodological guidance, preventative programs, timely data collecting, good reviews and audits, uniform evaluation, and standardization. Slovakia has no centralized system for tracking the prevalence of PU.<sup>(5)</sup>

The absence of PU, seen as a sign of inadequate care, continues to be a vital issue for nurses. Patients and their loved ones know that PU is painful and takes a long time to heal. PU and injuries are more likely to occur in people who are older, less mobile, incontinent, have impaired nutrition and hydration, have impaired neurosensory function, experience skin pressure from medical equipment, have many chronic health conditions, and have irregular circulation. In 95 % of cases, PU can be avoided. Adult pressure ulcer prevalence ranges from zero in hospitals to twelve percent in nursing homes, twenty-four percent to fifty-three percent in

hospitals, and one percent to ninety-nine percent in nursing homes for the elderly. Pressure ulcer incidence has declined in recent years in the United States.<sup>(6)</sup>

When it comes to early-stage decubitus ulcers, the multifunctional integrated sensor can identify them thanks to its strong association with the biophysical indicators of skin ischemia and integrity, such as temperature and impedance.<sup>(7)</sup> Chaudon et al.<sup>(8)</sup> illustrated the viability of a single system that utilizes two non-invasive techniques—impedance spectroscopy and transdermal drug administration via iontophoresis—to identify, monitor, and treat PU. Azman et al.<sup>(9)</sup> described conceptualizing and implementing a novel pressure ulcer intervention method suitable for seated and bedridden patients. Hickie et al.<sup>(10)</sup> proposed a strategy for preventing PU by having patients wear wireless sensors in vulnerable areas. The sensor collects data on local pressure over time and wirelessly sends it to a control center or mobile device. Anjusha et al.<sup>(11)</sup> suggested a pressure-sensing bed mat with a target of reducing bed pressure through pressure detection to avoid pressure sores. Aldughayfiq et al.<sup>(12)</sup> described a unique method for identifying PU and separating them into four stages using the advanced and reliable object detection model YOLOv5. Cao et al.<sup>(13)</sup> focused on creating a warning system to aid in the early and precise clinical prediction of PU. Minter et al.<sup>(14)</sup> evaluated two pressure ulcer monitoring platform (PUMP) prototype devices to encourage hospitalized patients to reposition themselves in their beds in the most advantageous way possible to avoid developing PUs. Monroy et al.<sup>(15)</sup> suggested a fuzzy postural change monitoring system that uses tiny inertial sensors sewn into patients' clothing to identify in-bed postures. Continuous pressure monitoring (CPM) was used to analyze the movement patterns of people with spinal cord injury (SCI) during their inpatient rehabilitation period while assessing the trends in people who had skin damage.<sup>(16)</sup> Therefore, we suggested developing a wearable technology for nursing home residents to use in the early detection of PU.

The remaining sections of this research are as follows: methodology is introduced in part 2; the result of the study is in part 3; the discussion is found in part 4; the conclusion is in part 5.

## METHODS

The suggested method uses a wearable ultra-low power device to continually track the patient's whereabouts and update it on a digital log on the hospital's cloud system.

### Hardware design

The wearable device's hardware in a functional block diagram part is depicted in figure 1. A single package incorporating a “3-axis accelerometer, 3-axis gyroscope, and 3-axis magnetometer” makes up the device's 9-axis MEMS “Inertial Measurement Unit (IMU).” They each have the following full-scale values:

- Accelerometer reading: +/- 2 g
- +/- 250 rad/sec gyroscope
- +/-1200Ut on the Magnetometer

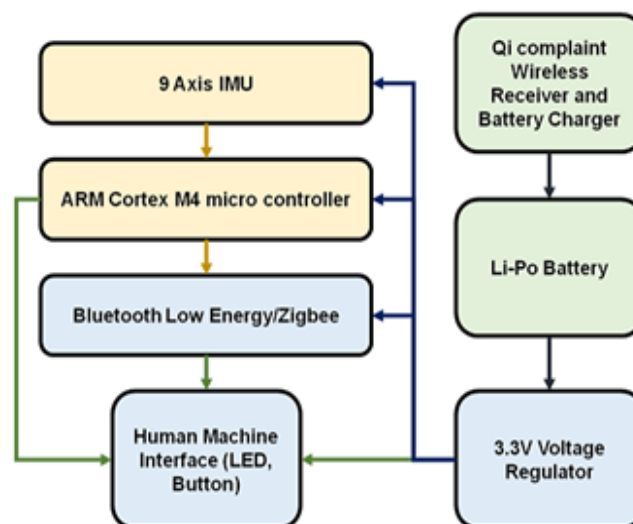

**Figure 1.** Wearable device's hardware of functional block diagram

Each sensor module's sampling rate is set to 10 samples per second (Sps) along each axis to reduce power consumption and allow continuous use. The algorithm operates on a 32-bit ARM Cortex M4 microcontroller (MCU), which communicates with the other modules. The IMU and MCU use I2C protocol to interact; power is

conserved by only waking the MCU up when data is ready due to an interrupt system. After processing the raw sensor data, the MCU executes the algorithm to determine the patient's position. Bluetooth low energy (BLE) protocol is used for wireless communication between the MCU and the gateway (tablet). The power supply incorporates a 170mAh LiPolymer battery, a 3,3V low drop-out voltage regulator, a receiver coil, and a battery charger compatible with Qi wireless power. Due to its energy-efficient components and intelligent algorithm, the device has a minimum operating time of 10 days between charges. Sterile and biocompatible ABS protects the PCB, completed components, receiver coil, and battery.

### Software design

The total system's software design can be separated into three categories:

#### *Software for the Gateway Interfacing*

The nurse can interact with the wearable gadget using this app, which runs on a tablet. The interface facilitates a more effective HAPU prevention process, lighting the nurse's workload. Basic patient information entering is the interface's first stage. Utilizing the Braden scale, risk assessment is the next step. At this stage, the nurse can select the diagnosis that best characterizes the patient's condition across all assessed dimensions. The Braden scale score will be shown once the evaluation is finished. In addition to the score, the patient's risk status is displayed. There could be a low, medium, or high chance of anything happening. If the patient's risk score is high, the interface will prompt the nurse to have them use the monitor. After connecting a wearable device to the patient, the gateway (tablet) may track their whereabouts in real-time. The nurse must choose a cutoff from a predetermined range of degrees to identify a turn distinct from other motion types. The nurse will modify the patient's default settings to account for their level of mobility. Using a color-coded system, the computer notifies and automatically helps the nurse through the turn operation.

- Green means the patient is not scheduled for a turn.
- Amber indicates a patient who is about to turn.
- The red indicates a patient turn is urgently needed; the position should be changed.

A daily patient skin assessment option is also offered via the user interface. The interface allows the nurse to choose the appropriate pressure ulcer stage at each site. This concludes the nurse's overall procedure for delivering efficient care to prevent HAPUs.

#### *Software for wearable devices*

A software timer is initiated when the gadget is fastened to the patient. The nurse's inputs entered into the tablet interface are used to configure the widget before its initial use. Connecting the patient's location in real-time to the gateway (tablet) enables centralized monitoring. The device's sophisticated algorithm converts the raw data from the 9 Axis sensors into quaternions, which may be utilized to locate the patient within millimeters. The sensor's present orientation is compared to predetermined turn criteria to determine if the patient has been turned. The patient's location is only updated 15 seconds after a change in position is detected, preventing false alarms by rapid jerks. The wearable gadget determines the patient's location based on the subsequent events. The following are needed to make a left turn: the present direction exceeds the required angle to turn to the right. The current focus is further than the proper turn limit. Supine: the new direction reduced threshold for a turning point upper bound the nurse gets updated on the patient's status every two hours and a reminder to take any necessary measures.

#### *Healthcare software is based in the cloud*

The hospital's cloud-based program monitors patients and keeps a real-time digital trail of their movements, which communicates with the tablet-based gateway. The software allows users to look back at previous patient placements if needed. It also provides a centralized control panel, accessible via the gateway (tablet), from which all patient locations may be monitored in real-time.

### Classification using water wave optimization with convolution neural network

In this piece, we'll go through WWO fundamentals. The WWO method is a metaheuristic solution to global optimization problems. Each key has a height ( $h$ ) and a wavelength ( $\lambda$ ), and together, they form a "wave" on the ocean floor, as described by WWO. Using the distance from the seafloor to where the water is entirely motionless, we may determine the fitness of each wave. The WWO algorithm uses a population where each wave has a max of 0,5. With WWO, you may think of each iteration as a progression through these three operations propagations, refraction, and breaking—toward a global optimum. If we follow the logic of (1), we can create a new wave ( $Y$ ) by adding the displacement along each axis ( $c$ ).

$$Y_i = Y_i + \text{rand}(-1,1) \times \lambda \times K_c \quad (1)$$

In this context,  $K_c$  is the search space size in the city dimension, where  $d$  is the duration of a unique function for producing random numbers within a specific range.

$$\lambda = \lambda \times \alpha^{\frac{-(e(Y)-e_{min}+\epsilon)}{(e_{max}-e_{min}+\epsilon)}} \tag{2}$$

This is because deep-water waves have highly long wavelengths and low amplitudes. Shallow water waves have similarly modest wave heights and wavelengths. A wave's wavelength will decrease from deep to shallow water. Solving for  $Y$  in (15) yields each wave's wavelength  $Y$ .

$$Y, = \text{Gaussian} (\mu, \sigma) \tag{3}$$

To prevent division by zero, we designate the fitness of a wave  $Y$  as  $f(Y)$ , where  $f_{max}$  and  $f_{min}$  are the maximum and minimum fitness values in the current population, is the parameter for the wavelength reduction coefficient, and is a minor constant. Fewer, more powerful waves can travel more irregular distances with this aid. The refraction operator is used to achieve a vertical wave height of zero. The resulting wave ( $Y'$ ) is based on a Gaussian function, a statistical distribution with a known mean and standard deviation.

Mean ( $\mu$ ) is defined in equation 3, whereas standard deviation ( $\sigma$ ) is calculated using equations (3) and (4).

$$\mu = \frac{Y_{bestd} + Yc}{2} \tag{4}$$

$$\sigma = \frac{Y_{bestd} - Yc}{2} \tag{5}$$

The average ( $\mu$ ) is calculated using the current wave ( $Y$ ) and the optimal wave ( $Y_{bestd}$ ). The difference between the best wave ( $Y_{bestd}$ ) and the recent wave ( $Y$ ) is the standard deviation ( $\sigma$ ). Additionally, the wavelength is determined by (19), and the wave height is reestablished to the max.

$$\lambda' = \frac{e(Y)}{e(Y_c)} \tag{6}$$

The formula for the next wave's wavelength is given by (6), where is the frequency of the initial wave,  $Y'$  is the frequency of the current wave, and  $f(Y)$  is the fitness of both the recent surge and the previous wave. To eliminate the wave ( $Y$ ), the splitting operator ( $e$ ) must eventually outperform the best-known solution at the time ( $Y_{bestd}$ ). To calculate the solitary wave ( $Y'$ ), we use (7)

$$Y, = Y + \text{Gaussian} (0,1) \times B \times Kc \tag{7}$$

The random integer between 0 and 1 is generated using the 0-1 Gaussian functions, denoting the rupture frequency. If wave  $Y'$  is superior to wave  $y$ ,  $y^{\wedge}$  will take its place.

Each successive layer's last group of characteristics might be considered symbolic tweaks to the image. Each convolutional kernel in a series used by a WWO feature generated within a basic convolutional layer modifies an intermediate data chunk. The depth of the feature mappings in convolutional layer  $l$  is proportional to

$$(V^l, H^l) = \left[ \frac{(V^{l-1}, H) + 2s^{L-f^1}}{T^l} + 1 \right] \tag{8}$$

Where is for incorrect operations, is for width, and is for breadth. Every output feature unit is computed using the class. Even though and are not required, the temperature in the room is relatively high. This is true regardless of the size or intricacy of the cover for the show's location. The class determines each feature unit in the output.

$$x_i^l = \varphi(\sum_{i \in M_j} y_i^{l-1} \times f_{ij}^l + d_j^l) \tag{9}$$

If  $x_i^l = y_i^{l-1}$ , then  $d_j^l$  is a variable, and  $M_j$  is susceptible

**Activation function**

Non-linearity mappings that forecast matrix area employ an activation function. For even better training, this technique makes use of rectified linear units.

### Pooling layer

The pooling layer would be a top pick among convolution blocks that involve data convolution while maintaining spatial rotational stability. In this method, a max-pooling layer employs localized pooling by holding on to its maximal perceptron while discarding more minor data.

### Testing and Validation

Device testing and validation were done in a controlled environment to see how well the algorithm tracked the patient's position. To replicate a patient with limited movement, an experiment was put up. Two volunteers helped with the investigation; volunteer number one played the nurse role, and volunteer number two played the part of the patient. The patient had a wearable gadget attached to his chest. The gateway (tablet) continuously recorded the patient's location. Before the trial, turn thresholds were established. One trial lasted for a total of five minutes.

When the experiment began, the patient was lying supine on the bed. After that, the patient was to be moved once per minute by the order in table 1 until the end of the trial. The patient's location over time and as measured by the sensor's rotation in degrees, was recorded by the gateway (tablet). Position updates of the patient along the sequence are displayed in table 1.

Time Interval (sec)	Computer monitoring of the patient's posture	Current location of the patient
171	Right	Right
111	Left	Left
231	Supine	Supine
291	Left	Left
51	Supine	Supine

## RESULTS

The proposed method's effectiveness is compared to that of previously employed strategies like support vector machine (SVM), convolutional neural network (CNN), and decision tree (DT). This research uses Python tools. Important metrics like accuracy, precision, recall, and F1-score were investigated utilizing new and existing methods.

### Experimental setup

We used a supervised strategy in which the patient position was assigned to each data saved in the dataset. Six participants with various profiles in terms of age, weight, and gender were used to collect the data by donning hospital gowns. The latter was equipped with a collection of wearable gadgets that recorded the body position while engaging in five different physical activities, including sitting still, being prone, supine, lying on one's right and left sides, and moving. We have refrained from using the patients' proper names and last names, as well as from including their faces in pictures, out of respect for their privacy. Table 2 displays all the measurements taken by the patient's wearable sensors, organized by row and labeled according to their location on the body after combining all the data points at different timestamps. We gathered 8708 samples after the process, a good quantity of data for our model to be trained. From there, we created a train set, validation set, and test set, with the former having dimensions of 85 % by 85 % and the latter of 15 % by 15 % of the complete dataset. The validation set comprised 15 % of the training data in terms of quantity and percentage.

Id	Timestamp	Mx	My	Mz	Ax	Ay	Az	Pos
5	2018/07/30 23 : 23 : 45	11,45	-35,36	3,67	8,43	4,98	0,51	Right
4	2018/07/27 22 : 37 : 15	4,73	21,91	-33,16	-4,67	-8,87	1,80	Sitting
0	2018/07/22 19 : 37 : 15	26,82	8,18	-1,02	-0,04	0,24	9,77	Supine
1	2018/07/24 19 : 42 : 15	-14,73	40,27	8,98	7,53	-5,41	3,14	Left

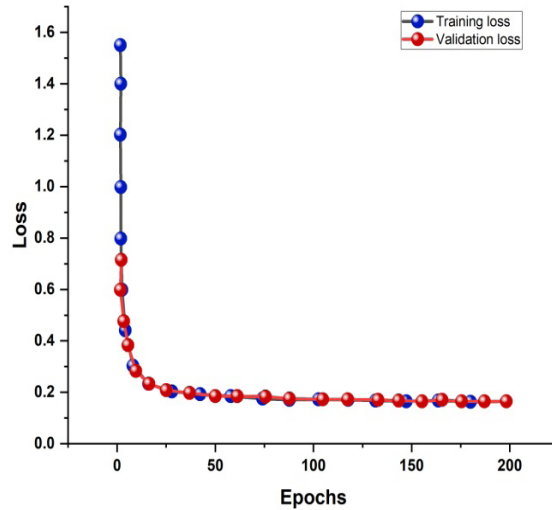

Figure 2. Valid loss with training average development curves

As the number of training epochs continues to rise, the learning curves generated by computing the train and validation losses are depicted in figure 2. Both curves converge on a value very near zero, suggesting that the model has correctly learned the connection between input and output.

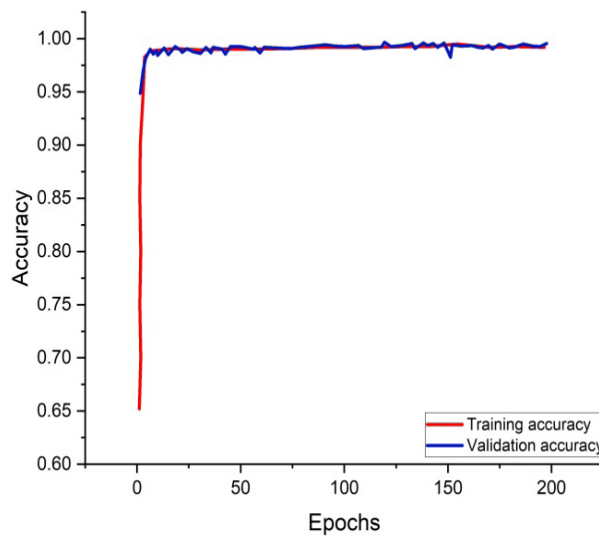

Figure 3. Train and validate set accuracy performance curves

Figure 3 shows how the training and validation accuracy performance curves change over time, which helps diagnose the learning dynamics. These curves depict validation and training data accuracy. The accuracy of a statement can be determined by dividing the number of words by the corresponding number of accurate classifications. The system’s accuracy depends on the classifier’s ability to categorize students’ results correctly. In mathematics, precision means,

$$Accuracy = \frac{(TP + TN)}{(TP + TN + FP + FN)} \tag{10}$$

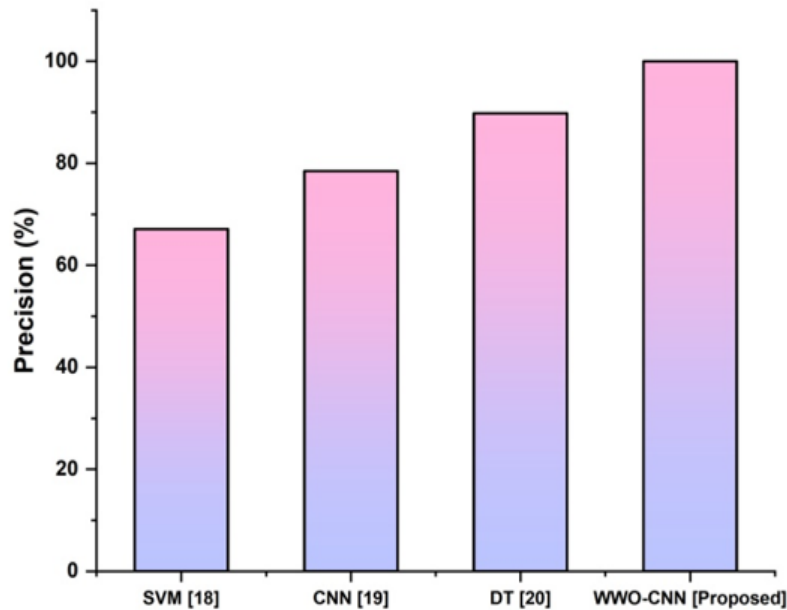

Figure 4. Comparison of the precision

Figure 4 displays a comparison of the precision. Precision can also be assessed using a positive predictive value (PPV) statistic. The number of correct class predictions from particular sample measures accuracy. In other words, it contrasts the actual outcomes with the predictions. To determine how precise an observation is, apply the formula below:

$$\text{Precision} = \text{True positive} / \text{Total predicted positive} \quad (11)$$

Compared to other approaches like SVM, CNN, and DT, the suggested method WWO-CNN demonstrates that estimates from a sample image have higher precision.

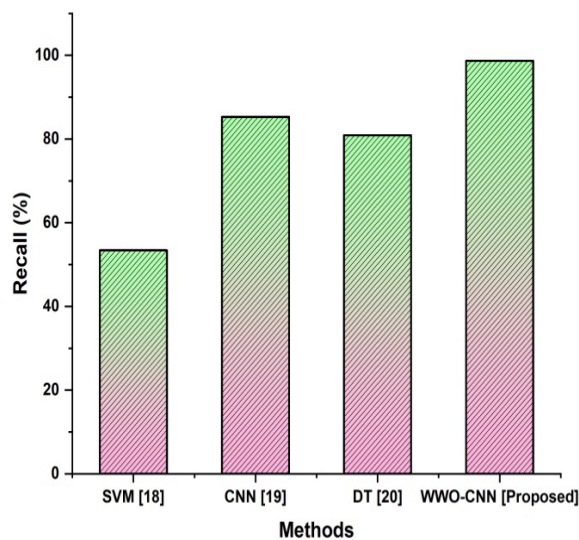

Figure 5. Comparison of the recall

Figure 5 compares the proposed and existing recall techniques. The recall is a metric to evaluate how well medical imaging information systems can locate the appropriate additional sample for cancer patients. It has been determined that the following processes are essential:



$$\text{Recall} = \text{True positive} / \text{Total number of actual positives} \quad (12)$$

The WWO-CNN methodology, which also has a greater recall than other approaches like SVM, CNN, and DT, was used sample data to find the evidence in support.

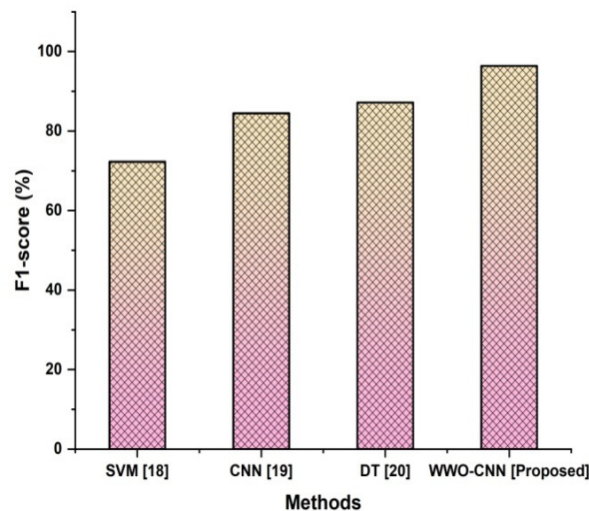

**Figure 6.** Comparison of the F1-score

Figure 6 displays a comparison of the F1 score. The F1 score takes precision and memory into account as well. The average or median of two distributions is known as the frequency mean. The response time means a cutting-edge method for calculating an average of numbers is sometimes more suitable for ratios than traditional statistical distributions. Compared to methods like SVM, CNN, and DT, the suggested way of WWO-CNN has a higher F1 score.

## CONCLUSIONS

We examined the issue of PU production when the skin is subjected to continual pressure over an extended period and proposed a deep-learning strategy in this research. Wearable technology may solve this problem by creating a cheap, user-centered system that doesn't need any particular installation or hardware. We designed a WWO-CNN and tested it in a real-world situation by analyzing the system's behavior on several patients to ensure its efficacy and viability. The encouraging outcomes demonstrate that deep learning algorithms tuned to individual tasks perform better than SVM, CNN, and DT. This study evaluated metrics like accuracy, precision, recall, and F1-score. The suggested WWO-CNN has 99 % accuracy, 100 % precision, 98,7 % recall, and a 96,4 % F1-score as its output. Patients' health, including the avoidance of PUs, can be reliably enhanced by employing these strategies. Research in the future will continue to broaden this analysis by comparing and contrasting several potential alternatives, both in terms of academic resources and commercial offerings. In terms of the latter, we'll be looking at how quickly the system responds, how well it handles exchanging data in real time, and how well the various parts of the system, especially the wearable sensors, function.

## REFERENCES

1. Jackson D, Sarki AM, Betteridge R, Brooke J. Medical device-related pressure ulcers: a systematic review and meta-analysis. *Int J Nurs Stud.* 2019;92:109-120.
2. Gaspar S, Peralta M, Marques A, Budri A, Gaspar de Matos M. Effectiveness on hospital-acquired pressure ulcer prevention: a systematic review. *Int Wound J.* 2019;16(5):1087-1102.
3. Gefen A, Alves P, Ciprandi G, Coyer F, Milne CT, Ousey K, Ohura N, Waters N, Worsley P, Black J, Barakat-Johnson M. Device-related pressure ulcers: SECURE prevention. *J Wound Care.* 2022;31(Sup3a):S1-S72.
4. Tsikriteas ZM, Roscow JI, Bowen CR, Khanbareh H. Flexible ferroelectric wearable devices for medical applications. *Science.* 2021;24(1):101987.

5. Grešš Halász B, Bérešová A, Tkáčová L, Magurová D, Lizáková L. Nurses' knowledge and attitudes towards prevention of pressure ulcers. *Int J Environ Res Public Health*. 2021;18(4):1705.
6. Ebi WE, Hirko GF, Mijena DA. Nurses' knowledge of pressure ulcer prevention in public hospitals in Wollega: a cross-sectional study design. *BMC Nurs*. 2019;18(1):1-12.
7. Kim SR, Lee S, Kim J, Kim E, Kil HJ, Yoo JH, Oh JH, Jeon J, Lee EI, Jeon JW, Jeon KH. A fabric-based multifunctional sensor for the early detection of skin decubitus ulcers. *Biosens Bioelectron*. 2022;215:114555.
8. Chaudon MJ, Hulea O, Yakoub A, Monnier P, Saadaoui M. A wearable device for iontophoretic treatment and monitoring of pressure ulcers: Proof-of-concept. *Med Eng Phys*. 2022;107:103861.
9. Azman AW, Fajingbesi FE, Ahmad Z, Mustafah YM, Olanrewaju RF, Hamzaid NA. Electrical stimulation in combating pressure ulcer for immobilizing subjects: A conceptual framework. *J Phys Conf Ser*. 2019;1372(1):012056.
10. Hickie K, Slamir R, Baez A, Sen D, Evan-Browning E, Tessier H, Mendelson Y, McNeill J, Dunn R. Wireless Pressure Ulcer Sensor: Validation in an Animal Model. *Ann Plast Surg*. 2019;82(4S):S215-S221.
11. Anjusha AK, Nageswaran S. An Intelligent Bed Mat for Prevention of Pressure Ulcer. *ICAICTSEE-2020*. 2020;190.
12. Aldughayfiq B, Ashfaq F, Jhanjhi NZ, Humayun M. YOLO-Based Deep Learning Model for Pressure Ulcer Detection and Classification. *Healthcare*. 2023;11(9):1222.
13. Cao S, Yan F, Zhang C, Lu J, Jiang C, Zhou W, Lu X. Research and development of "SMART+" pressure ulcer warning instrument and system. In: 2021 11th International Conference on Information Technology in Medicine and Education (ITME). IEEE; 2021. p. 314-318.
14. Minter DM, Simon P, Taylor DP, Jia W, Li Y, Sun M, Rubin JP. Pressure ulcer monitoring platform—a prospective, human-subject clinical study to validate patient repositioning monitoring device to prevent pressure ulcers. *Adv Wound Care*. 2020;9(1):28-33.
15. Monroy EB, Rodríguez AP, Estevez ME, Quero JM. Using inertial sensors attached to clothing, fuzzy monitoring of in-bed postural changes to prevent pressure ulcers. *J Biomed Inform*. 2020;107:103476.
16. Fryer S, Caggiari S, Major D, Bader DL, Worsley PR. Continuous pressure monitoring of inpatient spinal cord injured patients: implications for pressure ulcer development. *Spinal Cord*. 2023;61(2):111-118.
17. Cicceri G, De Vita F, Bruneo D, Merlino G, Puliafito A. A deep learning approach for pressure ulcer prevention using wearable computing. *Hum Centric Comput Inf Sci*. 2020;10(1):1-21.
18. Monroy EB, Romero DZ, Estévez ME, Cruciani F, Cleland I, Nugent C, Medina-Quero J. Intelligent system for preventing pressure ulcers by monitoring postural changes with wearable inertial sensors. *Multidiscip Digit Publ Inst Proc*. 2019;31(1):79.
19. Liu TJ, Christian M, Chu YC, Chen YC, Chang CW, Lai F, Tai HC. A pressure ulcer assessment system for diagnosis and decision-making using convolutional neural networks. *J Formos Med Assoc*. 2022;121(11):2227-2236.
20. Vijayalakshmi A, Jose DV. A Machine Learning Approach For IoT Enabled Pressure Ulcer Detection. In: *Conference Secretariat*; 2021. p. 52.

#### **FUNDING**

No financing.

#### **CONFLICTS OF INTEREST**

None.

**AUTHOR CONTRIBUTIONS**

*Conceptualization:* Bhargavi Deshpande, Malathi Hanumanthayya, Ram Niwas.

*Methodology:* Bhargavi Deshpande, Malathi Hanumanthayya, Ram Niwas.

*Drafting - original draft:* Bhargavi Deshpande, Malathi Hanumanthayya, Ram Niwas.

*Writing - proofreading and editing:* Bhargavi Deshpande, Malathi Hanumanthayya, Ram Niwas.